

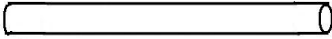









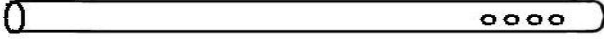





# 5 x 8 m PVC STYCK LISTA

Artikel-nummer		Beskrivning	Antal
1		Galvaniserat rör Diameter 38mm 550mm	10
2		Galvaniserat rör diameter 38mm 1940mm	22
4		Galvaniserat rör diameter 38mm 1920mm	10
5		2-vägs led	10
6		3-vägs led	4
7		4-vägs led	6
8		3-vägs led	2
9		4-vägs led	3
10		Fot	10
11		Jordankare	4
12		Jordspjut	10
13		Jordspjut	42
14		Resårstropp	22
15		Resårstropp	106
16		Tältlina	4
17		Skruv	74
18		Takduk	1
19		Gavel	2
20		Sidovägg	8

**I** Sätt alla rör och leder tillsammans som visas på bilden nedan.

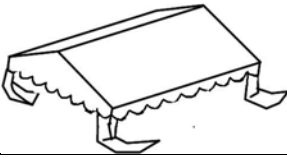
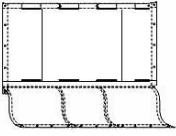
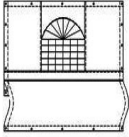
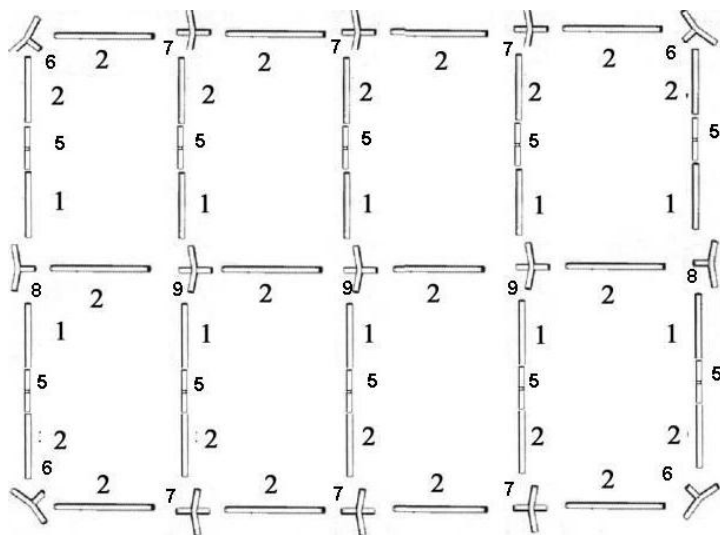

**II** Lyft ena sidan och montera rör nr. 4.

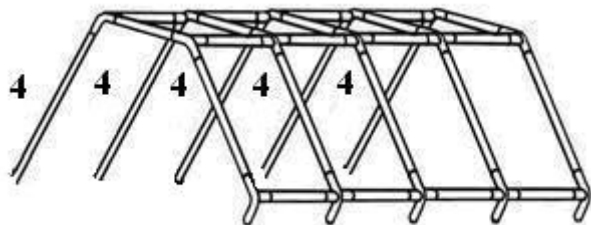

**III** Sätt på takduken.

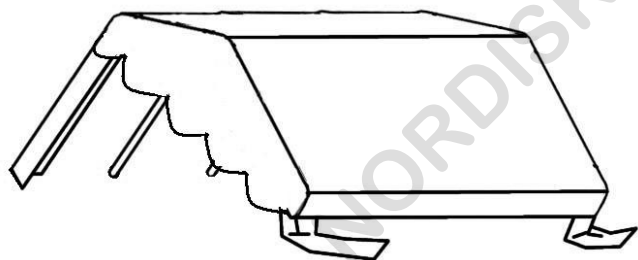

**IV** Använd resårstroppar för att fastmontera takduken.

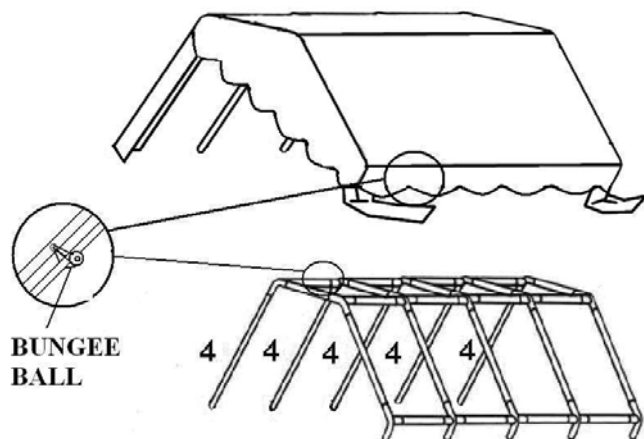

**V** Lyft motsatt sida. Montera på fötterna.

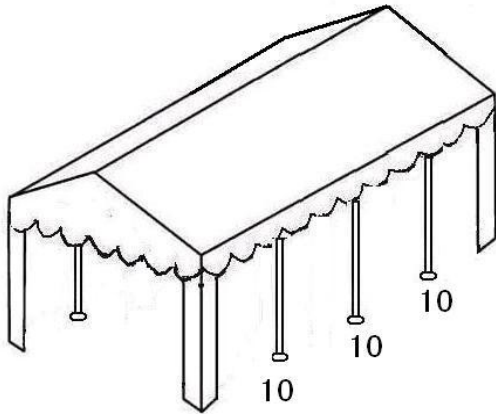

**VI** Montera sidoväggar och gavlar, använd också här resårstroppar.

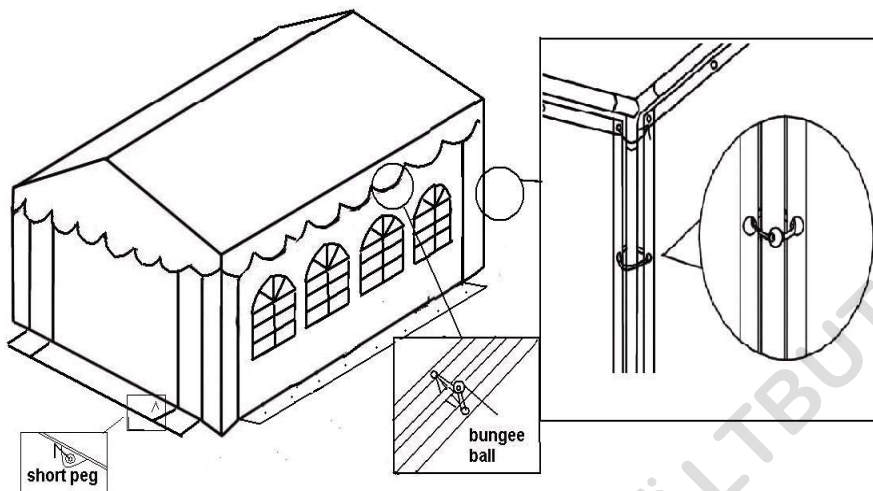

**VII** Använd jordspjut och tärtlina för att göra tältet mer stabilt.

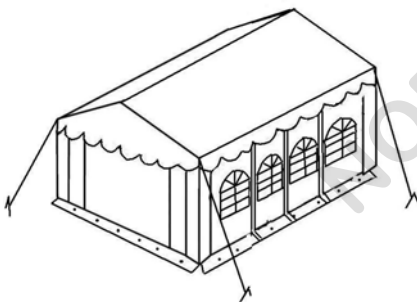



### **Viktigt**

1. Var försiktig med delarna under uppsättning och nedtagning, annars kan de bli skadade.
2. Tältet är inte konstruerat för att stå uppsatt i långa perioder. Om det blir oväder skall det nedmonteras.
3. Finn en bra plats till tältet. Undvik automatisk bevattning och kablar i jorden.
4. Även om denna produkt är flammhämmande ska man vara försiktig. Ha ej eld och andra värmekällor nära tältet.

Bilderna som används i denna manual är endast en illustration som och kan skilja sig från köpt modell.



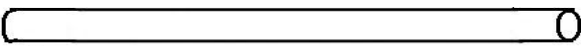
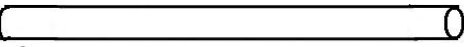

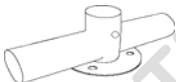
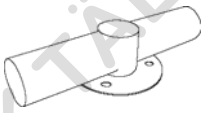
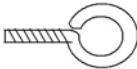
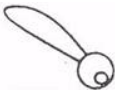

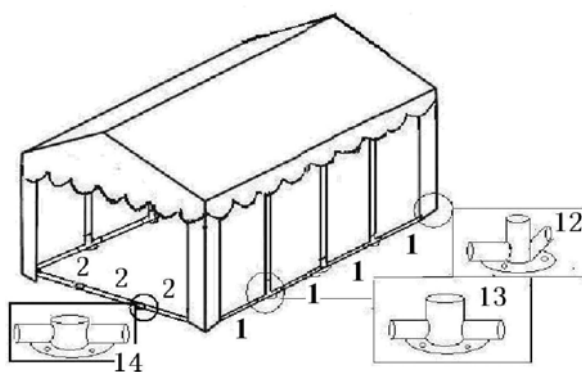



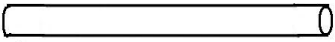
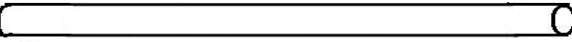
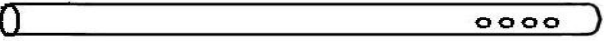
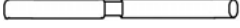

## 5 x 8 m BOTTENRAM

1. Följ monteringsvägledning för tältet.
2. Montera fötterna (12&13) på benen (3) (Fig.4), i stället för standard fötterna som följer med tältet. Använd bultar för att fästa dem med.
3. När fötterna är monterade kan bottenramen monteras (1&2) på fötterna . (12.14.13)
4. Fäst sidoväggar och gavlar till bottenramen med resårstroppar.

NO.1 X 8		Bottenram 1940mm
NO.2 X 6		Bottenram 1600mm
NO.12X 4		Fot hörna
NO.13X 6		Fot sidovägg
NO.14X 4		Fot gavel
BT X 38		Bult
BGX 36		Resårstropp

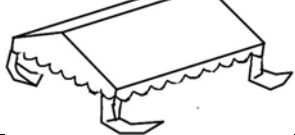
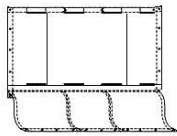
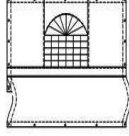

# 5 x 8 m PVC STYK LISTE

Artikel-nummer		Beskrivelse	Antal
1		Galvaniseret rør Diameter 38mm 550mm	10
2		Galvaniseret rør diameter 38mm 1940mm	22
4		Galvaniseret rør diameter 38mm 1920mm	10
5		2-vejs samling	10
6		3-vejs samling	4
7		4-vejs samling	6
8		3-vejs samling	2
9		4-vejs samling	3
10		Fod	10
11		Jordanker	4
12		Jordspyd	10
13		Jordspyd	42
14		Elastik	22
15		Elastik	106
16		Teltline	4
17		Skrue	74
18		Tagdug	1
19		Gavl	2
20		Sidevæg	8

**I** Sæt alle rør og samlinger sammen som vist på billedet.

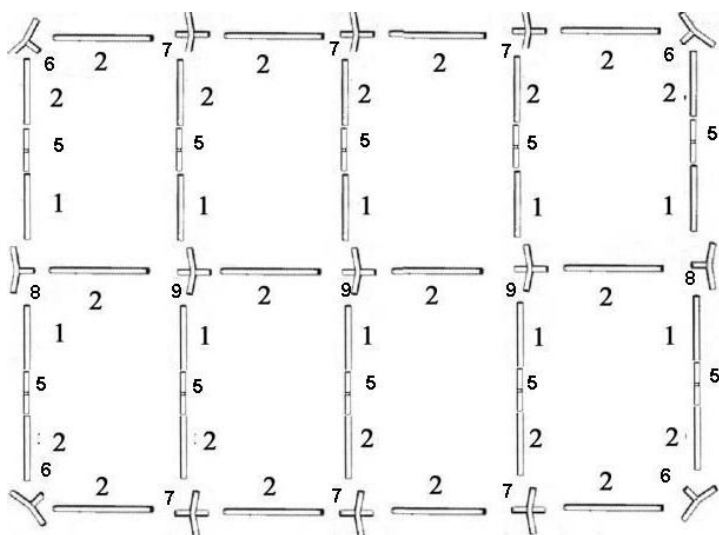

**II** Løft den ene side og monter rør nr. 4.

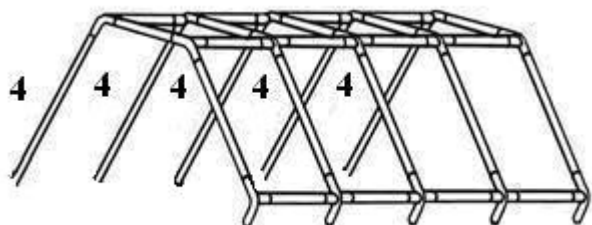

**III** Bred tagdugen ud over stellet.

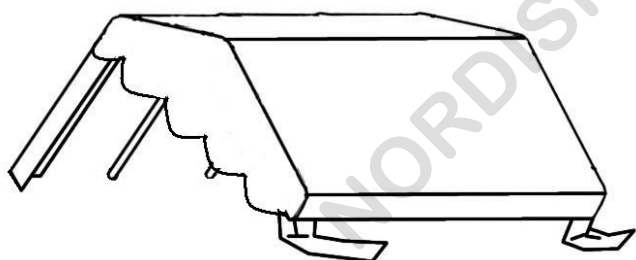

**IV** Anvend elastikker for at fastmontere tagdugen på stellet.

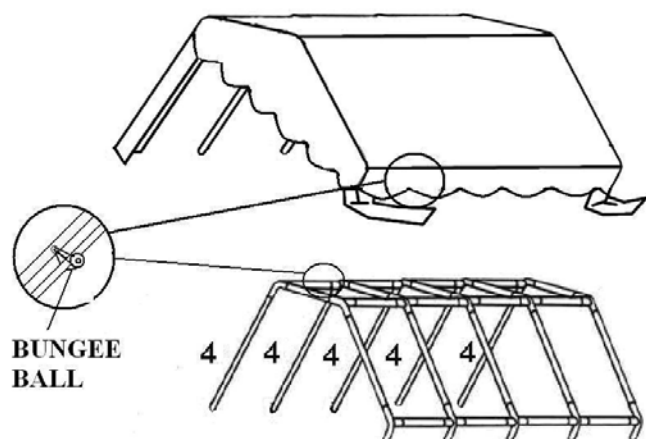

**V** Løft modsatte side. Monter fødderne.

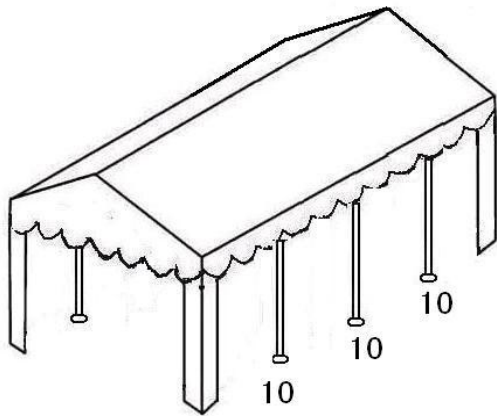

**VI** Monter sidevægge og gavle. Anvend elastikker.

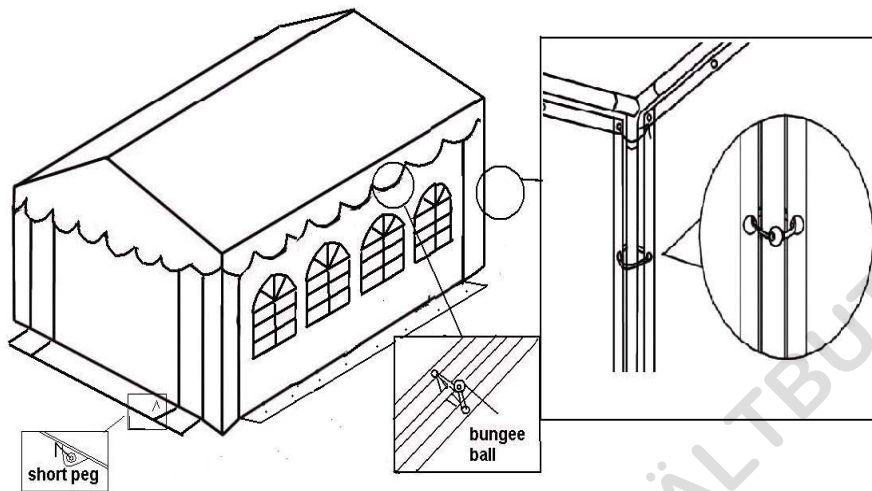

**VII** Anvend jordspyd og teltliner, til at gøre teltet mere stabilt.

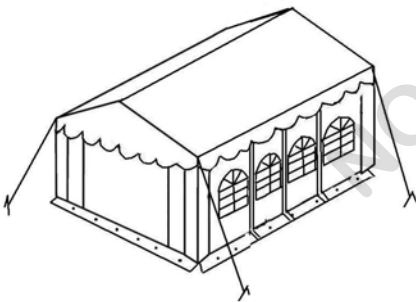





### **Vigtigt**

1. Vær forsigtig med delene under opsætning og nedtagning. Ellers kan de blive beskadiget.
2. Teltet er ikke konstrueret til at stå opsat i længere perioder. Hvis det bliver hårdt vejr skal det nedmonteres.
3. Find en egnet plads til teltet. Undgå sprinkler anlæg og kabler i jorden.
4. Selvom dette produkt er flamme hæmmende skal man være forsigtig. Hold åben ild og andre varme kilder væk fra teltet.

Billederne der er brugt i denne manual er kun til illustration, og kan afvige fra den købte model.

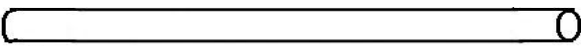
## 5 x 8 m BUNDRAMME

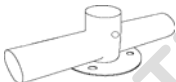
1. Følg samlevejledningen for teltet.
2. Monter fødderne (12&13) på benene (3) (Fig.4), i stedet for standard fødderne som følger med teltet. Anvend bolte for at fastgøre dem.
3. Når fødderne er monteret kan bundrammen monteres (1&2) på fødderne. (12.14.13)
4. Sæt sidevægge og gavle fast til bundrammen med elastikker.

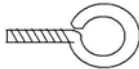
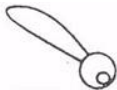
NO.1 X 8		Bundramme 1940mm
NO.2 X 6		Bundramme 1600mm
NO.12X 4		Fod hjørne
NO.13X 6		Fod sidevæg
NO.14X 4		Fod gavl
BT X 38		Bolt
BGX 36		Elastik

